

# Adagio<sup>PRO</sup>

English..... Page 2  
Nederlands..... Pagina 18  
Français..... Page 34  
Deutsch..... Seite 50  
Español..... página 66

- 
-  RGB
  -  Cool white
  -  Warm white
  -  Blue
  -  Tunable white

# OWNER'S MANUAL

GEBRUIKSHANDLEIDING  
MODE D'EMPLOI

BETRIEBSANLEITUNG  
INSTRUCCIONES

## Table of contents

Technical specifications	Page 3
Remarks	Page 4
Box contents	Page 4
Installation instructions	Page 5-6-7
Wiring instructions setup 1	Page 8-9
Wiring instructions setup 2	Page 10-11
Wiring remarks	Page 12
Retrofit in PAR56 niche (only PLP170)	Page 14
14 Color programs	Page 15
Synchronizing & color changing	Page 16
Troubleshooting	Page 17

**DURAVISION**

## Technical specifications

Lamp Type	Description	Voltage	Power	Nom. Tc	Lumen
PLP050-RGB	RGB color 50 mm	10-14 VAC	10 W	n.a.	400 lm
PLP100-RGB	RGB color 100 mm	10-14 VAC	45 W	n.a.	1700 lm
PLP170-RGB	RGB color 170 mm	10-14 VAC	75 W	n.a.	3000 lm
PLP050-WH	Sun White 50 mm	10-14 VAC	6 W	7000K	600 lm
PLP100-WH	Sun White 100 mm	10-14 VAC	30 W	7000K	2600 lm
PLP170-WH	Sun White 170 mm	10-14 VAC	60 W	7000K	5500 lm
PLP050-WW	Warm White 50 mm	10-14 VAC	6 W	3300K	540 lm
PLP100-WW	Warm White 100 mm	10-14 VAC	30 W	3300K	2350 lm
PLP170-WW	Warm White 170 mm	10-14 VAC	60 W	3300K	4950 lm
PLP050-BL	Blue fixed 50 mm	10-14 VAC	6 W	n.a.	165 lm
PLP100-BL	Blue fixed 100 mm	10-14 VAC	25 W	n.a.	470 lm
PLP170-BL	Blue fixed 170 mm	10-14 VAC	60 W	n.a.	1450 lm
PLP050-TW	Tunable white 50 mm	10-14 VAC	10 W	3000-6500K	500 lm
PLP100-TW	Tunable white 100 mm	10-14 VAC	45 W	3000-6500K	2150 lm
PLP170-TW	Tunable white 170 mm	10-14 VAC	75 W	3000-6500K	4250 lm



For operation only with a safety isolation transformer



IEC Protection Class III

Minimum input voltage: **10 VAC 50/60 Hz**  
(at lamp terminals)

Operation on DC voltages is NOT allowed

Nominal input voltage: **12 VAC 50/60 Hz**  
(at lamp terminals)

Maximum water temperature: **+40°C**

Maximum input voltage: **14 VAC 50/60 Hz**  
(at lamp terminals)

Ingress protection rate:

Power factor: **> 0,90**

Lamps have to be kept  
out of ice zones  
**IP68**  
measured at 3m  
max depth = 3m

## Remarks

The luminaire is maintenance free

If the luminaire needs to be replaced, it needs to be completely removed from the water



If the external flexible cable or cord of this luminaire is damaged, it shall be exclusively replaced by the manufacturer or his service agent or a similar qualified person in order to avoid hazard



*Adagio<sup>PRO</sup> Pool lamps must be completely submerged into water during operation. Fixing the lamps with adhesives or silicone kit into a niche is not allowed. Not following these instructions, will void warranty.*

## Box contents

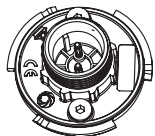

ADAGIO<sup>PRO</sup>  
Lamp (50,100  
or 170 mm)

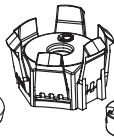

Connection Kit  
ADAGIO<sup>PRO</sup>  
( 513-0152 or 513-0219 )

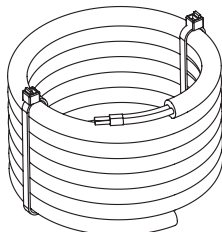

4m Cable



Manual

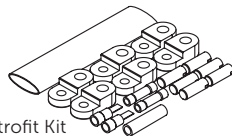

Retrofit Kit  
(only for 170mm models)

## Installation instructions

### mounting the connector

### mounting face plate

Contact your local distributor for  
Toolset: 513-0151  
( not included )

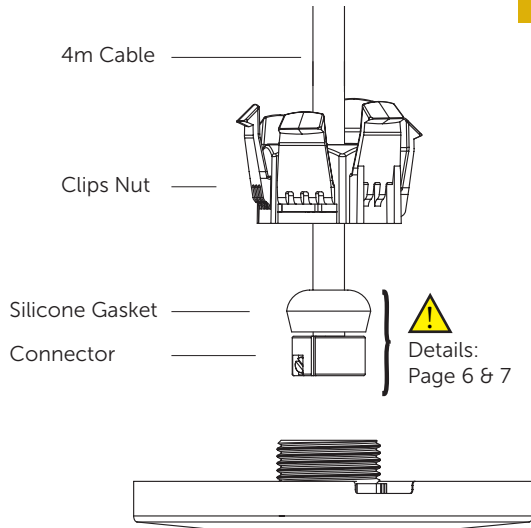
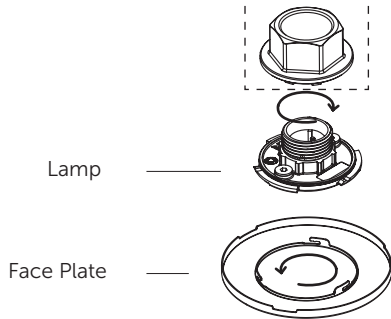

## Connector installation

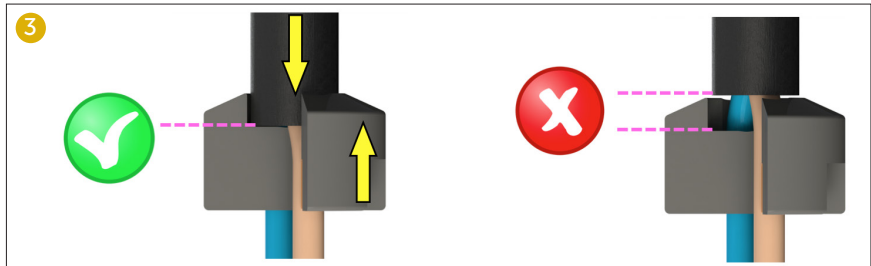
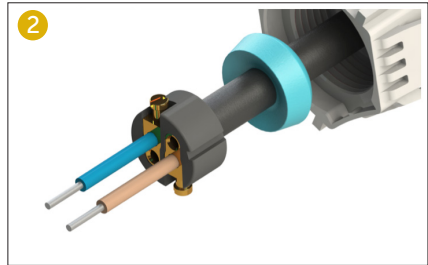
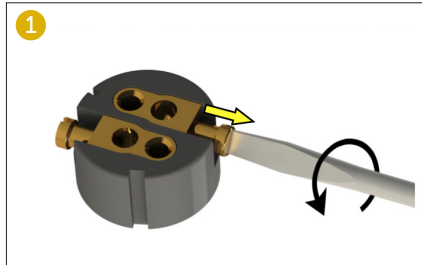

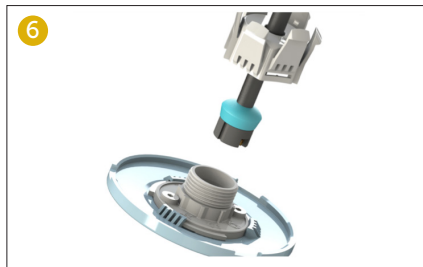
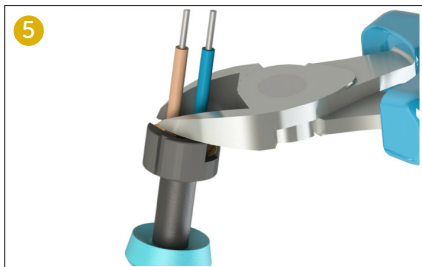

## Wiring instructions Setup 1

### For new installations

Each lamp is connected to the transformer by a separate cable

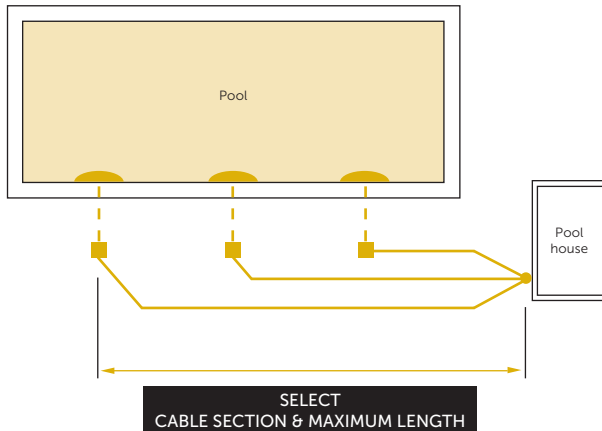

- 4m cable included in lamp package
- Separate cable ( not included )



Always use a toroidal transformer



### SELECT CABLE SECTION & MAXIMUM LENGTH

LAMP TYPE	1,5mm <sup>2</sup>	2,5mm <sup>2</sup>	4,0mm <sup>2</sup>	6,0mm <sup>2</sup>	10mm <sup>2</sup>	VA TRANSFORMER (12VAC)*	
 <ul style="list-style-type: none"> <li> PLP050-WH</li> <li> PLP050-WW</li> <li> PLP050-BL</li> <li> PLP050-RGB / TW</li> </ul>	122m	204m	326m	490m	820m	8 VA	
	79m	132m	212m	318m	530m	12 VA	
	 <ul style="list-style-type: none"> <li> PLP100-WH</li> <li> PLP100-WW</li> <li> PLP100-BL</li> <li> PLP100-RGB / TW</li> </ul>	26m	43m	69m	104m	173m	32 VA
		15m	25m	41m	61m	100m	48 VA
 <ul style="list-style-type: none"> <li> PLP170-WH</li> <li> PLP170-WW</li> <li> PLP170-BL</li> <li> PLP170-RGB / TW</li> </ul>		11m	19m	30m	46m	75m	66 VA
		8m	14m	23m	35m	57m	80 VA

**STABLE OPERATION OF THE POOL LIGHTS IS ONLY GUARANTEED WHEN THE INSTALLED CABLE CROSS SECTION MATCHES OR EXCEEDS THE ADVISED VALUES IN THE ABOVE TABLE**

\* The transformer VA rating must be greater or equal to the sum of VA ratings of all connected lamps. These cable lengths are calculated with worst case voltage drops in the electrical wiring.

## Wiring instructions Setup 2

### For existing or other installations

All lamps are connected to the transformer via 1 cable

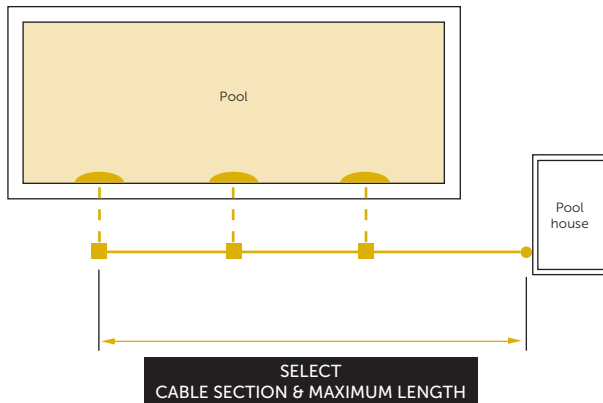















- 4m cable included in lamp package
- Separate cable ( not included )



This setup is not preferred for installations where a PLP-REM(-300) is used

SELECT  
CABLE SECTION & MAXIMUM LENGTH

LAMP TYPE	QTY	2,5mm <sup>2</sup>	4,0mm <sup>2</sup>	6,0mm <sup>2</sup>	10mm <sup>2</sup>	VA TRANSFORMER (12VAC)	
	 PLP050-WH	1	204m	326m	490m	820m	8
	 PLP050-WW	2	102m	163m	245m	410m	16
	 PLP050-BL	3	68m	108m	163m	273m	24
		4	51m	81m	122m	205m	32
		1	132m	212m	318m	530m	12
	PLP050-RGB / TW	2	66m	106m	159m	265m	24
		3	44m	70m	106m	176m	36
		4	33m	53m	79m	132m	48
	 PLP100-WH	1	43m	69m	104m	173m	32
	 PLP100-WW	2	21m	34m	52m	86m	64
	 PLP100-BL	3	14m	23m	34m	57m	96
		4	10m	17m	26m	43m	128
		1	25m	41m	61m	100m	48
	PLP100-RGB / TW	2	12m	20m	30m	50m	96
		3	8m	13m	20m	33m	144
		4	6m	10m	15m	25m	192
	 PLP170-WH	1	19m	30m	46m	75m	66
	 PLP170-WW	2	9m	15m	23m	37m	132
	 PLP170-BL	3	6m	10m	15m	25m	198
		4	-	6m	11m	18m	264
		1	14m	23m	35m	57m	80
	PLP170-RGB / TW	2	7m	11m	17m	28m	160
		3	-	7m	11m	19m	240
		4	-	5m	8m	14m	320

**STABLE OPERATION OF THE POOL LIGHTS IS ONLY GUARANTEED WHEN THE INSTALLED CABLE CROSS SECTION MATCHES OR EXCEEDS THE ADVISED VALUES IN THE ABOVE TABLE**

## Wiring remarks

### For installations with PLP-REM & PLP-REM-300

Third party equipment such as frequency inverters and electric motors can generate excessive noise on the 230VAC / 400VAC power line.

This noise might be injected into the adjacent 12VAC power line and disturb the power line communication towards the Adagio<sup>Pro</sup> RGB lights.

To prevent this, please take care of the following:



**Keep 230VAC / 400VAC power line cables at least 50cm separated over their full length from the 12VAC power line towards any RGB lights**



**Do not mix 12VAC and 230VAC / 400VAC power line cables into the same cable trays**

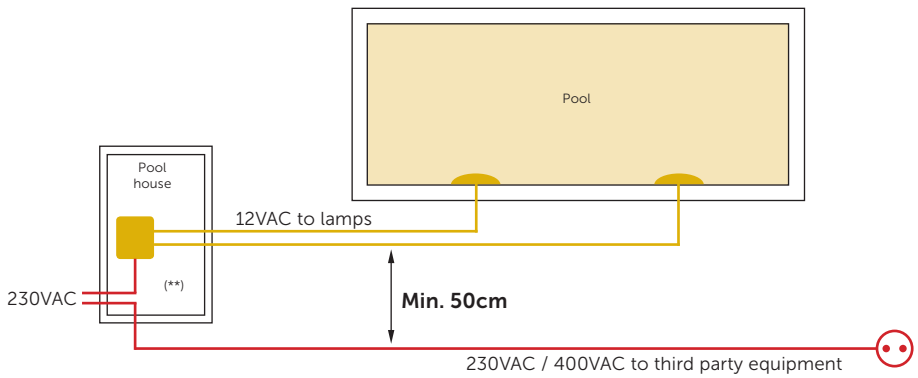

(\*\*) Do not mix 12VAC and 230VAC / 400VAC power line cables into the same cable trays

## Retrofit in PAR56 niche (only PLP170)

1



2

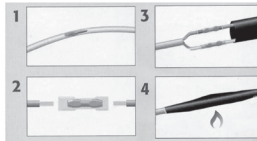

If old cable is re-used

OR

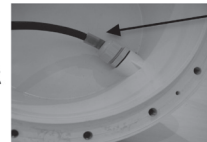

Silicone tube

If new (thinner) cable is used

3



## Color programs



### RGB LAMPS

#### 7 fixed colours

- 1 DEEP BLUE SEA**  
Saturated blue
- 2 DAYLIGHT BLUE**  
Light blue
- 3 SUNSET**  
Orange red
- 4 LOVE IS IN THE AIR**  
Red
- 5 FOREST SPRING**  
Green
- 6 THINK PINK**  
Pink
- 7 SUNSHINE**  
Yellow

#### 4 dynamic colors

- 8 JUNGLE BEACH**  
Saturated blue  
Light blue  
Azur blue  
Mid blue  
Light blue  
(slowly changing)
- 9 VODOO**  
Red - Wine red -  
Purple - Bordeaux  
(slowly changing)
- 10 DISCO**  
Lila - pink - peach -  
light yellow  
light green  
light blue  
(quickly changing)
- 11 PARTY**  
Blue - azur blue -  
green - green/red -  
red - blue - lila -  
light pink - peach -  
yellow - light green -  
light blue - lila  
(quickly changing)

#### 3 white tones

- 12 WARM WHITE**  
3000K
- 13 NEUTRAL WHITE**  
6000K
- 14 SUN WHITE**  
10.500K



### TW LAMPS

#### 7 white tints

- 1 3200K**
- 2 3800K**
- 3 5400K**
- 4 7300K**
- 5 14800K**
- 6 LIGHT BLUE**
- 7 BLUE**

\* all color programs are dimmable if PLP-REM or PLP-REM-300 are used (in PLC mode)

## Synchronizing & color changing (for RGB and TW lamps only)

### Manual synchronization

1. Switch ON the 12 VAC line voltage and make sure that all lamps light up.
2. Switch OFF the 12 VAC line voltage and wait for at least 20 sec.
3. Switch ON and switch OFF
4. Switch ON and switch OFF
5. Switch ON
6. The lamps should now all be on color program 1  
for RGB lamps: fixed blue light (Deep blue Sea)  
for TW lamps: 3200K

### Changing colors

Quickly turn the lamps OFF and back ON

The lamp will jump to the next color program ( 1 --> 14 )

### Memorizing the last color

Turn the lamp OFF for MINIMUM 20 seconds

The last chosen color has now been memorized

The use of **PLP-REM** or **PLP-REM-300** control units enables extended features like automatic synchronisation, dimming and DMX / RS485 control



## Troubleshooting

### PROBLEM

- The pool light is flickering

### SOLUTION

1. Switch the lamps ON  
For RGB lamps: select the Sun White color program
2. Remove the lamp from the water, unscrew the clips nut, pull back the gasket and the black cable jacket, so you can reach the brass contacts inside the connector block (do not remove the connector block)
3. Measure the voltage at the lamp terminals (while the lamp is still ON)
4. The voltage at the lamp should be at least 10VAC 50/60hz.  
If the measured line voltage is below 10VAC:
  - A. Check the output voltage at the transformer terminals.  
This voltage should be between 12VAC and 14VAC.  
Verify that the used transformer VA rating is sufficient for powering all connected lamps
  - B. If the transformer output voltage is ok, then install a thicker cable between the transformer and the lamp.  
(wiring instructions p. 8-13)

- 
- Several pool lights in the pool show different color programs

Make sure that all lamps are connected to the same 12VAC power line. Execute the synchronization as explained on p.16

## Inhoudstafel

Technische specificaties	<b>Pagina 19</b>
Opmerkingen	<b>Pagina 20</b>
Inhoud van de doos	<b>Pagina 20</b>
Installatie-instructies	<b>Pagina 21-22-23</b>
Kableringschema type 1	<b>Pagina 24</b>
Kableringschema type 2	<b>Pagina 26</b>
kablering opmerkingen	<b>Pagina 28</b>
Retrofit in PAR56 nis (alleen PLP170)	<b>Pagina 30</b>
14 kleurprogrammas	<b>Pagina 31</b>
Synchroniseren & kleur veranderen	<b>Pagina 32</b>
Probleemoplossing	<b>Pagina 33</b>

**DURAVISION**

## Technische specificaties

Model	Omschrijving	Spanning	Vermogen	Nom. Tc	Lumen
PLP050-RGB	RGB kleur 50 mm	10-14 VAC	10 W	n.a.	400 lm
PLP100-RGB	RGB kleur 100 mm	10-14 VAC	45 W	n.a.	1700 lm
PLP170-RGB	RGB kleur 170 mm	10-14 VAC	75 W	n.a.	3000 lm
PLP050-WH	Koud wit 50 mm	10-14 VAC	6 W	7000K	600 lm
PLP100-WH	Koud wit 100 mm	10-14 VAC	30 W	7000K	2600 lm
PLP170-WH	Koud wit 170 mm	10-14 VAC	60 W	7000K	5500 lm
PLP050-WW	Warm Wit 50 mm	10-14 VAC	6 W	3300K	540 lm
PLP100-WW	Warm Wit 100 mm	10-14 VAC	30 W	3300K	2350 lm
PLP170-WW	Warm Wit 170 mm	10-14 VAC	60 W	3300K	4950 lm
PLP050-BL	Blauw 50 mm	10-14 VAC	6 W	n.a.	165 lm
PLP100-BL	Blauw 100 mm	10-14 VAC	25 W	n.a.	470 lm
PLP170-BL	Blauw 170 mm	10-14 VAC	60 W	n.a.	1450 lm
PLP050-TW	Regelbaar wit 50 mm	10-14 VAC	10 W	3000-6500K	500 lm
PLP100-TW	Regelbaar wit 100 mm	10-14 VAC	45 W	3000-6500K	2150 lm
PLP170-TW	Regelbaar wit 170 mm	10-14 VAC	75 W	3000-6500K	4250 lm



Uitsluitend te gebruiken met een veiligheidstransformator

Minimum ingangsspanning: **10 VAC 50/60 Hz**  
(aan de lampaansluiting)

Nominale ingangsspanning: **12 VAC 50/60 Hz**  
(aan de lampaansluiting)

Maximale ingangsspanning: **14 VAC 50/60 Hz**  
(aan de lampaansluiting)

Power factor: **> 0,90**



IEC Protectie klasse III

Gebruik met DC spanning is NIET toegestaan

Maximum water temperatuur: **+40°C**

*Houd de lamp weg*

*uit zones met ijs*

**IP68**

gemeten op 3m  
max diepte = 3m

Bescherming:

## Opmerkingen

De lamp is onderhoudsvrij

Moet de lamp vervangen worden, moet dit volledig uit het water gebeuren.



Als de externe flexibele kabel of koord van de lamp beschadigt is, zal deze uitzonderlijk vervangen worden door de fabrikant of soortgelijk gekwalificeerd persoon, dit om gevaarlijke situaties te voorkomen.



*Adagio<sup>pro</sup> lampen moet volledig worden ondergedompeld in water tijdens het gebruik.  
De lampen bevestigen met lijm of siliconen is niet toegelaten  
De garantie vervalt wanneer deze richtlijnen niet gevolgd worden*

## Inhoud van de doos

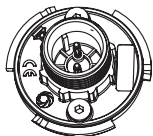

ADAGIO<sup>PRO</sup> Lamp  
(50,100 of 170 mm)

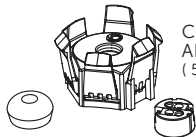

Connection Kit  
ADAGIO<sup>PRO</sup>  
( 513-0152 of 513-0219 )

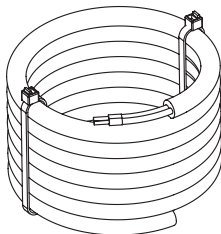

4m kabel



Handleiding

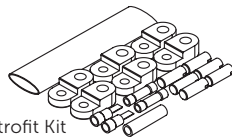

Retrofit Kit  
(alleen voor 170mm modellen)

## Installatie-instructies

### connector monteren

4m kabel

Clips Nut

Silicone pakking

Connector



Details:  
Pagina 22  
& 23

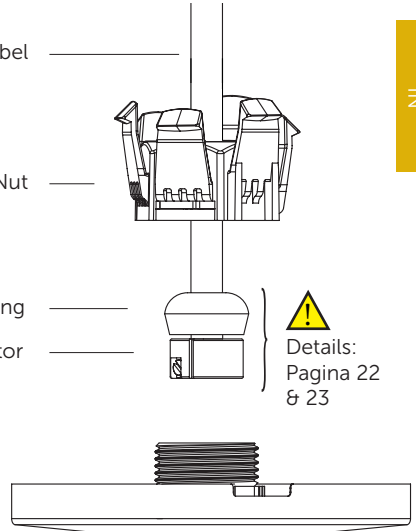

### face plate monteren

Contacteer uw  
distributeur voor  
Toolset: 513-0151  
(niet inbegrepen)

Lamp

Face Plate

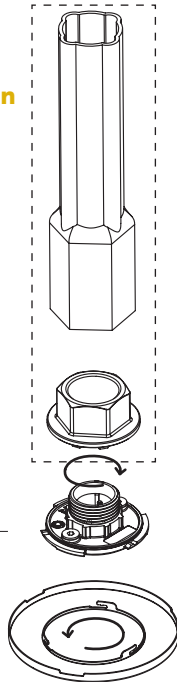

## Connector installatie

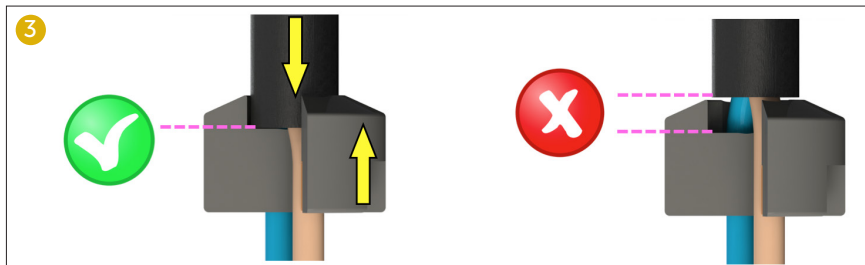
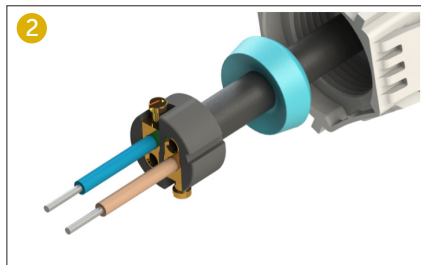
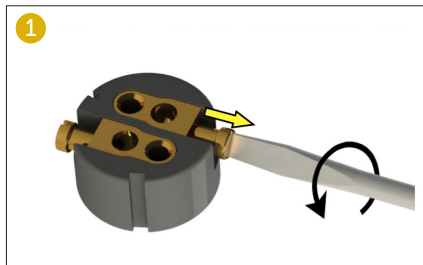

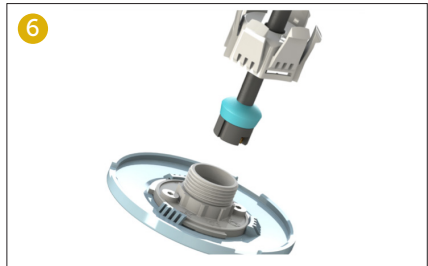
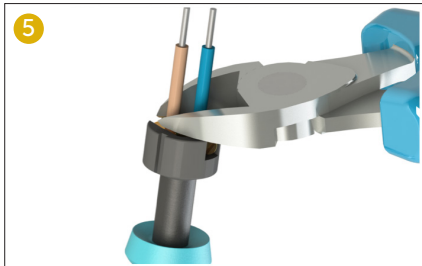

## Kableringschema Type 1

### Voor nieuwe installaties

Iedere lamp wordt rechtstreeks verbonden met de transformator

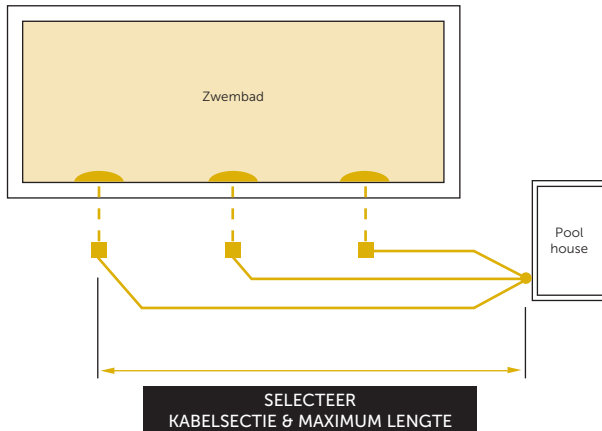



- 4m kabel inbegrepen bij de lamp
- Extra kabel (niet inbegrepen)



Gebruik altijd een ringenransformator



## SELECTEER KABELSECTIE & MAXIMUM LENGTE

LAMP TYPE	1,5mm <sup>2</sup>	2,5mm <sup>2</sup>	4,0mm <sup>2</sup>	6,0mm <sup>2</sup>	10mm <sup>2</sup>	VA TRANSFO (12VAC)*	
 <ul style="list-style-type: none"> <li> PLP050-WH</li> <li> PLP050-WW</li> <li> PLP050-BL</li> <li> PLP050-RGB / TW</li> </ul>	122m	204m	326m	490m	820m	8 VA	
	79m	132m	212m	318m	530m	12 VA	
	 <ul style="list-style-type: none"> <li> PLP100-WH</li> <li> PLP100-WW</li> <li> PLP100-BL</li> <li> PLP100-RGB / TW</li> </ul>	26m	43m	69m	104m	173m	32 VA
		15m	25m	41m	61m	100m	48 VA
 <ul style="list-style-type: none"> <li> PLP170-WH</li> <li> PLP170-WW</li> <li> PLP170-BL</li> <li> PLP170-RGB / TW</li> </ul>		11m	19m	30m	46m	75m	66 VA
		8m	14m	23m	35m	57m	80 VA

**DE STABIELE WERKING VAN DE LAMP IS ENKEL GEGARANDEERD WANNEER  
DE BOVENSTAANDE KABLERINGSINSTRUCTIES NAGELEEFD WORDEN**

\* Het vermogen van de transformator in VA moet groter of gelijk zijn aan het vermogen van alle verbonden lampen  
Deze kabellengtes werden berekend met het grootste mogelijke spanningsverlies in de bedrading.

## Kableringschema Type 2

### Voor bestaande of andere installaties

Alle lampen worden door middel van 1 kabel verbonden met de transformator

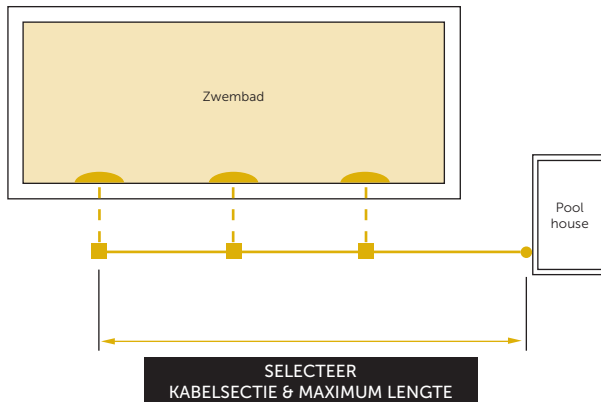















- 4m kabel inbegrepen bij de lamp
- Extra kabel (niet inbegrepen)



Deze opstelling wordt niet aangeraden  
voor installaties met PLP-REM(-300)  
Gebruik altijd een ringkerntransformator

SELECTEER  
KABELSECTIE & MAXIMUM LENGTE

LAMP TYPE	QTY	2,5mm <sup>2</sup>	4,0mm <sup>2</sup>	6,0mm <sup>2</sup>	10mm <sup>2</sup>	VA TRANSFO (12VAC)	
	 PLP050-WH	1	204m	326m	490m	820m	8
	 PLP050-WW	2	102m	163m	245m	410m	16
	 PLP050-BL	3	68m	108m	163m	273m	24
		4	51m	81m	122m	205m	32
		1	132m	212m	318m	530m	12
	PLP050-RGB / TW	2	66m	106m	159m	265m	24
		3	44m	70m	106m	176m	36
		4	33m	53m	79m	132m	48
	 PLP100-WH	1	43m	69m	104m	173m	32
	 PLP100-WW	2	21m	34m	52m	86m	64
	 PLP100-BL	3	14m	23m	34m	57m	96
		4	10m	17m	26m	43m	128
		1	25m	41m	61m	100m	48
	PLP100-RGB / TW	2	12m	20m	30m	50m	96
		3	8m	13m	20m	33m	144
		4	6m	10m	15m	25m	192
	 PLP170-WH	1	19m	30m	46m	75m	66
	 PLP170-WW	2	9m	15m	23m	37m	132
	 PLP170-BL	3	6m	10m	15m	25m	198
		4	-	6m	11m	18m	264
		1	14m	23m	35m	57m	80
	PLP170-RGB / TW	2	7m	11m	17m	28m	160
		3	-	7m	11m	19m	240
		4	-	5m	8m	14m	320

DE STABIELE WERKING VAN DE LAMP IS ENKEL GEGARANDEERD WANNEER  
DE BOVENSTAANDE KABLERINGSINSTRUCTIES NAGELEEFD WORDEN

NL

## Kablering opmerkingen

### Voor installaties met PLP-REM & PLP-REM-300

Andere toestellen zoals frequentie inverters of elektrische motors kunnen veel ruis veroorzaken op de 230VAC / 400VAC spanningslijn.

Het is mogelijk dat dit ruis geïnjecteerd wordt in een nabijgelegen 12VAC kabel, en dusdanig de communicatie naar de zwembadlampen verstoord.

Gelieve volgende maatregelen te treffen om dit te voorkomen:



**Houdt 230VAC / 400VAC voedingskabels uit de buurt van de 12VAC kabels van de lampen. De minimum afstand bedraagt 50cm, en dit over de gehele lengte van de kabel**



**Zorg ervoor dat er geen 12VAC en 230VAC / 400VAC kabels samen in eenzelfde kabelgoot liggen**

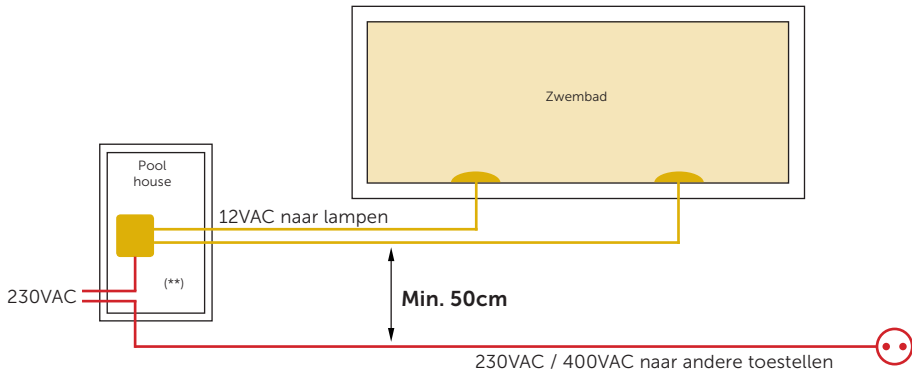

**(\*\*) Zorg ervoor dat er geen 12VAC en 230VAC / 400VAC kabels samen in eenzelfde kabelgoot liggen**



## Retrofit in PAR56 nis (alleen PLP170)

1



2

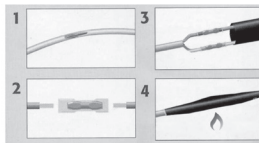

Als de originele kabel herbruikt wordt

OF

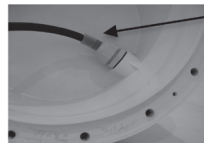

Silicone Tube

Als een nieuwe (dunnere) kabel gebruikt wordt

3

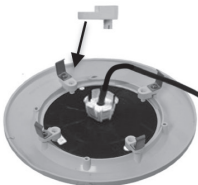

## kleurprogramma's

### RGB LAMPEN

#### 7 vaste kleuren

- 1 DEEP BLUE SEA**  
Verzadigd blauw
- 2 DAYLIGHT BLUE**  
Licht blauw
- 3 SUNSET**  
Oranje rood
- 4 LOVE IS IN THE AIR**  
Rood
- 5 FOREST SPRING**  
Groen
- 6 THINK PINK**  
Roze
- 7 SUNSHINE**  
Geel

#### 4 dynamische kleuren

- 8 JUNGLE BEACH**  
Verzadigd blauw  
Licht blauw  
Azur blauw  
Blauw  
Licht blauw  
(traag veranderend)
- 9 VODOO**  
Rood - Wijnrood -  
Paars - Bordeau  
(traag veranderend)
- 10 DISCO**  
Lila - roze - perzik -  
licht geel  
licht groen  
licht blauw  
(snel veranderend)
- 11 PARTY**  
Blauw - azur blauw -  
groen - groen/rood -  
rood - blauw - lila -  
licht roze - perzik -  
geel - light groen -  
licht blauw - lila  
(snel veranderend)

#### 3 witte tinten

- 12 WARM WHITE**  
3000K
- 13 NEUTRAL WHITE**  
6000K
- 14 SUN WHITE**  
10.500K

### TW LAMPEN

#### 7 witte tinten

- 1 3200K**
- 2 3800K**
- 3 5400K**
- 4 7300K**
- 5 14800K**
- 6 LICHT BLAUW**
- 7 BLAUW**

\* Alle kleurenprogramma's zijn dimbaar als de PLP-REM of PLP-REM-300 gebruikt worden (in PLC mode)

## Synchroniseren & kleur veranderen

### Manuele synchronisatie

1. Schakel de 12VAC voeding AAN en verifieer dat alle lampen branden
2. Schakel de 12VAC voeding UIT en wacht minstens 20 sec
3. Schakel AAN en terug UIT
4. Schakel AAN en terug uit
5. Schakel AAN
6. Alle lampen staan nu op programma 1  
voor RGB lampen: Verzadigd blauw (Deep Blue Sea)  
voor TW lampen: 3200K

### Kleur veranderen

Schakel de lampen snel achter elkaar UIT en weer AAN

De lampen zullen naar het volgende kleurenprogramma springen ( 1 --> 14 )

### De laatste kleur onthouden

Schakel de lampen uit en wacht MINIMUM 20 seconden

De laatst gekozen kleur is nu opgeslagen in het geheugen

Het gebruik van een PLP-REM of PLP-REM-300 maakt uitgebreide functies mogelijk zoals automatische synchronisatie, dimmen en DMX / RS485-besturing



## Probleemoplossing

### PROBLEEM

- De lamp flakkert

### OPLOSSING

- Zet de lamp AAN  
Voor RGB lampen: kies het Sun White kleurprogramma
- Haal de lamp uit het water, schroef de clips nut los, trek de rubber en cabelmantel terug, zodat je de koperen contactpunten reikt van de elektrische connectie (verwijder de elektrische connectie op de kabel niet)
- Meet de spanning aan de lamp (terwijl de lamp aan staat)
- De spanning aan de lamp moet minstens 10VAC 50/60hz zijn. Indien de gemeten waarde lager is dan 10VAC:
  - Verifieer de uitgangspanning van de transformator.  
Deze moet tussen 12VAC en 14VAC liggen.  
Vergewis U er van dat de VA specificatie van de transformator voldoende hoog is voor al de lampen.
  - Installeer een dikkere kabel indien de transformator voldoet (zie kableringschema's p. 24-29)

- 
- Verskillende lampen staan op een ander kleurprogramma

Ga na of alle lampen verbonden zijn met dezelfde 12V voedingslijn. Voer de synchronisatieprocedure uit van p.32 (Alleen voor de klassieke AAN/UIT sturing)

## Table des matières

Spécifications techniques	Page 35
Remarques	Page 36
Contenu de la boîte	Page 36
Guide d'installation	Page 37-38-39
Instructions de câblage – configuration 1	Page 40
Instructions de câblage – configuration 2	Page 42
Instructions de câblage – Remarques	Page 44
Mise à jour avec niche PAR56 (uniquement PLP170)	Page 46
14 programmes de couleurs	Page 47
Synchronisation & changement des couleurs	Page 48
Résolution des problèmes	Page 49

**DURAVISION**

## Spécifications techniques

Référence	Description	Tension	Puissance	Nom. Tc	Lumen
PLP050-RGB	Couleurs RGB 50 mm	10-14 VAC	10 W	n.a.	400 lm
PLP100-RGB	Couleurs RGB 100 mm	10-14 VAC	45 W	n.a.	1700 lm
PLP170-RGB	Couleurs RGB 170 mm	10-14 VAC	75 W	n.a.	3000 lm
PLP050-WH	Sun White 50 mm	10-14 VAC	6 W	7000K	600 lm
PLP100-WH	Sun White 100 mm	10-14 VAC	30 W	7000K	2600 lm
PLP170-WH	Sun White 170 mm	10-14 VAC	60 W	7000K	5500 lm
PLP050-WW	Warm White 50 mm	10-14 VAC	6 W	3300K	540 lm
PLP100-WW	Warm White 100 mm	10-14 VAC	30 W	3300K	2350 lm
PLP170-WW	Warm White 170 mm	10-14 VAC	60 W	3300K	4950 lm
PLP050-BL	Blue fixed 50 mm	10-14 VAC	6 W	n.a.	165 lm
PLP100-BL	Blue fixed 100 mm	10-14 VAC	25 W	n.a.	470 lm
PLP170-BL	Blue fixed 170 mm	10-14 VAC	60 W	n.a.	1450 lm
PLP050-TW	Blanc réglable 50 mm	10-14 VAC	10 W	3000-6500K	500 lm
PLP100-TW	Blanc réglable 100 mm	10-14 VAC	45 W	3000-6500K	2150 lm
PLP170-TW	Blanc réglable 170 mm	10-14 VAC	75 W	3000-6500K	4250 lm



À utiliser uniquement avec un transformateur d'isolement

Tension d'entrée minimum: **10 VAC 50/60 Hz**  
(aux bornes de la lampe)

Tension d'entrée nominale: **12 VAC 50/60 Hz**  
(aux bornes de la lampe)

Tension d'entrée maximale: **14 VAC 50/60 Hz**  
(aux bornes de la lampe)

Facteur de puissance: **> 0,90**



IEC Protection Classe III

L'opération sur les tensions continues n'est PAS autorisée

Température maximale  
de l'eau:

Indice de protection:

**+40 °C**

*Les lampes doivent être  
conservées à l'abri du gel*

**IP68**

mesuré à 3m  
max profondeur = 3m

## Remarques

Le luminaire est sans entretien

Si le luminaire doit être remplacé, il doit être complètement retiré de l'eau



Si le câble flexible externe de ce luminaire est endommagé, il doit être remplacé exclusivement par le fabricant ou son agent de service ou une personne qualifiée similaire pour éviter les risques



*Les lampes pour piscine Adagio PRO doivent être utilisées en étant entièrement submergées dans l'eau. Fixer les lampes avec des matières adhésives ou du silicone dans une niche n'est pas autorisé. Le non-respect de cette exigence entraîne l'annulation de la garantie*

## Contenu de la boîte

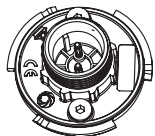

Lampe ADAGIO<sup>PRO</sup>  
(50,100 ou 170 mm)

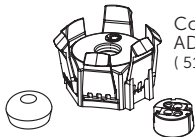

Connection Kit  
ADAGIO<sup>PRO</sup>  
( 513-0152 ou 513-0219 )

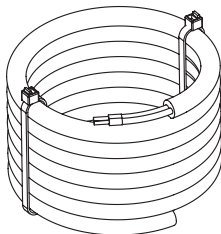

4m de câble



Mode d'emploi

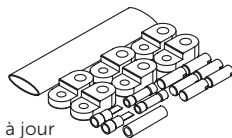

Kit de mise à jour  
(uniquement pour les modèles de 170mm)

## Montage de la collerette

Contactez votre distributeur local pour le kit d'outils 513-0151 (non fourni)

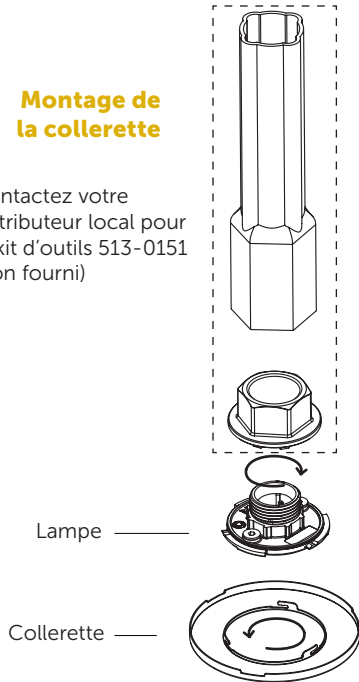

## Instructions d'installation

### Montage du connecteur

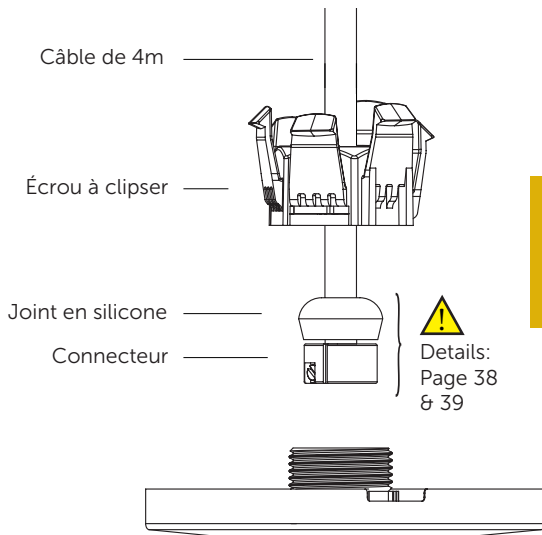

FR

## Montage du câble

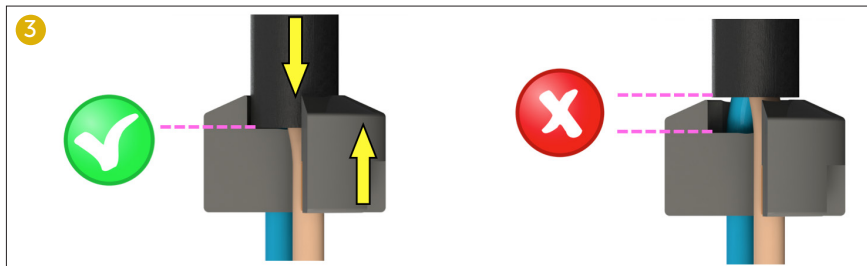
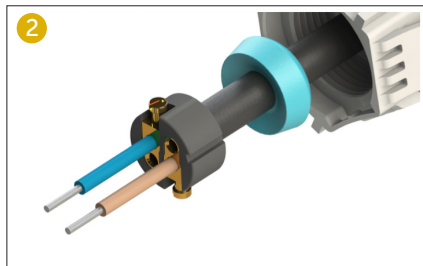
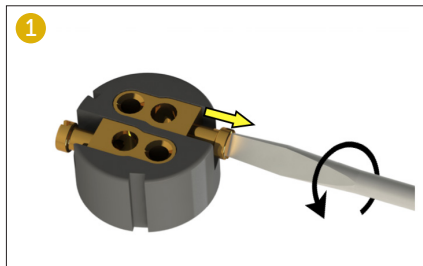

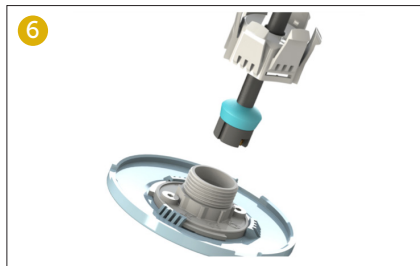
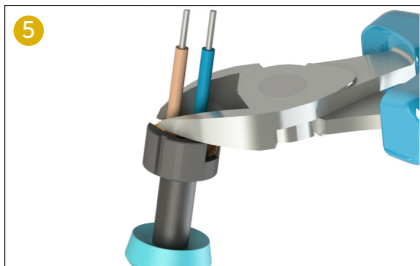

## Instructions de câblage - configuration 1

### Pour les nouvelles installations

Chaque lampe est raccordée au transformateur au moyen d'un câble séparé

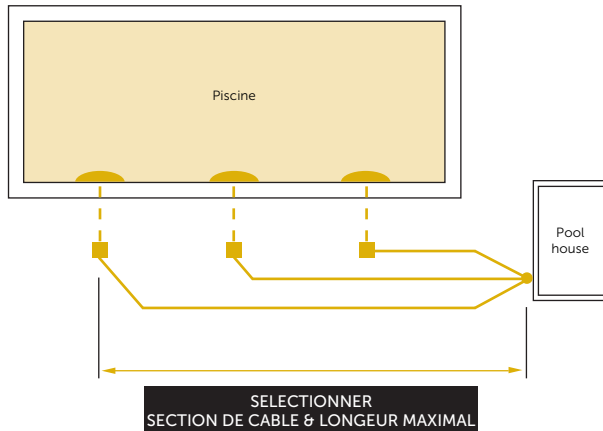















- - - - 4m câble fournis avec la lampe
- — — — Câble séparé (non fourni)



Utilisez toujours un transformateur torique



**SELECTIONNER  
SECTION DE CÂBLE & LONGEUR MAXIMAL**

TYPE DE LAMPE		1,5mm <sup>2</sup>	2,5mm <sup>2</sup>	4,0mm <sup>2</sup>	6,0mm <sup>2</sup>	10mm <sup>2</sup>	VA TRANSFORMATEUR (12VAC)*
	 PLP050-WH	122m	204m	326m	490m	820m	8 VA
	 PLP050-WW						
	 PLP050-BL						
	 PLP050-RGB / TW						
	 PLP100-WH	26m	43m	69m	104m	173m	32 VA
	 PLP100-WW						
	 PLP100-BL						
	 PLP100-RGB / TW						
	 PLP170-WH	11m	19m	30m	46m	75m	66 VA
	 PLP170-WW						
	 PLP170-BL						
	 PLP170-RGB / TW						

**L'OPÉRATION STABLE DES LAMPES N'EST GARANTI LORSQUE LA SECTION DE CÂBLE INSTALLÉE  
EST ÉGALE OU SUPÉRIEURE AUX VALEURS CONSEILLÉES DANS LE TABLEAU CI-DESSUS**

\* L'indice VA du transformateur doit être supérieur ou égal à la somme des indices VA de toutes les lampes connectées.  
Ces longueurs de câbles sont calculées en tenant compte des pires pertes de tension pouvant survenir dans le câblage électrique.

## Instructions de câblage - configuration 2

### Pour les installations existantes ou autres

Toutes les lampes sont raccordées au transformateur via 1 seul câble

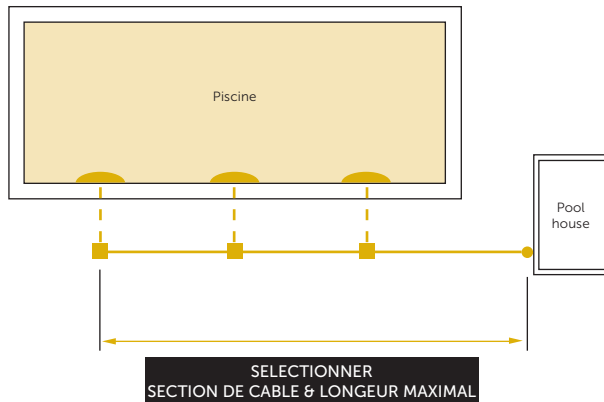































- - - - 4m câble fournis avec la lampe
- Cable séparé (non fourni)



Cette configuration n'est pas préférée pour les installations où un PLP-REM(-300) est utilisée.

Utilisez toujours un transformateur torique

**SELECTIONNER  
SECTION DE CÂBLE & LONGEUR MAXIMAL**

	TYPE DE LAMPE	QTY	2,5mm <sup>2</sup>	4,0mm <sup>2</sup>	6,0mm <sup>2</sup>	10mm <sup>2</sup>	VA TRANSFORMATEUR (12VAC)
	 PLP050-WH	1	204m	326m	490m	820m	8
	 PLP050-WW	2	102m	163m	245m	410m	16
	 PLP050-BL	3	68m	108m	163m	273m	24
	 PLP050-BL	4	51m	81m	122m	205m	32
	 PLP050-RGB / TW	1	132m	212m	318m	530m	12
	 PLP050-RGB / TW	2	66m	106m	159m	265m	24
	 PLP050-RGB / TW	3	44m	70m	106m	176m	36
	 PLP050-RGB / TW	4	33m	53m	79m	132m	48
	 PLP100-WH	1	43m	69m	104m	173m	32
	 PLP100-WW	2	21m	34m	52m	86m	64
	 PLP100-BL	3	14m	23m	34m	57m	96
	 PLP100-BL	4	10m	17m	26m	43m	128
	 PLP100-RGB / TW	1	25m	41m	61m	100m	48
	 PLP100-RGB / TW	2	12m	20m	30m	50m	96
	 PLP100-RGB / TW	3	8m	13m	20m	33m	144
	 PLP100-RGB / TW	4	6m	10m	15m	25m	192
	 PLP170-WH	1	19m	30m	46m	75m	66
	 PLP170-WW	2	9m	15m	23m	37m	132
	 PLP170-BL	3	6m	10m	15m	25m	198
	 PLP170-BL	4	-	6m	11m	18m	264
	 PLP170-RGB / TW	1	14m	23m	35m	57m	80
	 PLP170-RGB / TW	2	7m	11m	17m	28m	160
	 PLP170-RGB / TW	3	-	7m	11m	19m	240
	 PLP170-RGB / TW	4	-	5m	8m	14m	320

**L'OPÉRATION STABLE DES LAMPES N'EST GARANTIE LORSQUE LA SECTION DE CÂBLE INSTALLÉE  
EST ÉGALE OU SUPÉRIEURE AUX VALEURS CONSEILLÉES DANS LE TABLEAU CI-DESSUS**

## Instructions de câblage - remarques

### Pour les installations avec PLP-REM ou PLP-REM-300

Autres équipements comme variateurs de fréquence ou les moteurs électriques peuvent générer un bruit excessif sur la ligne électrique 230 VAC / 400 VAC

Ce bruit pourrait être injecté dans la ligne électrique 12VAC adjacente et perturber la communication des signaux vers les lumières RGB Adagio<sup>Pro</sup>.

Pour éviter cela, prenez soin de ce qui suit:



**Gardez les câbles de ligne 230 VAC / 400 VAC au moins 50cm séparés sur leur longueur totale de la ligne 12 VAC vers toutes les lumières RGB**



**Ne pas mélanger les câbles de ligne 12 VAC et 230 VAC / 400 VAC dans les mêmes goulottes de câbles.**

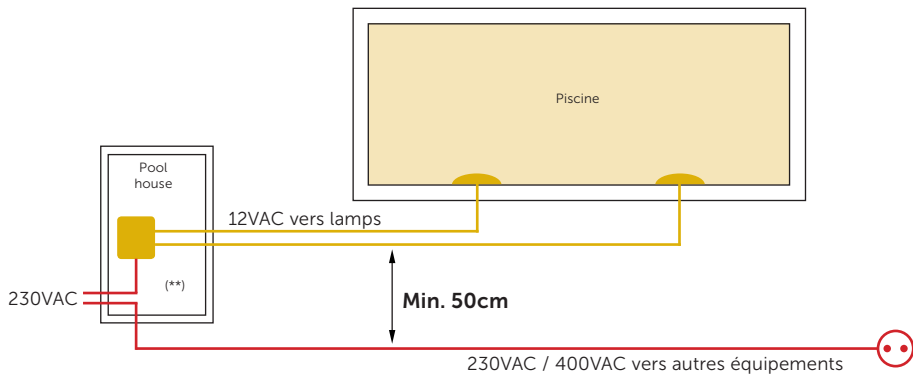

**(\*\*) Ne pas mélanger les câbles de ligne 12 VAC et 230 VAC / 400 VAC dans les mêmes goulottes de câbles.**

## Mise à jour avec niche PAR56 (uniquement PLA170)

1



2

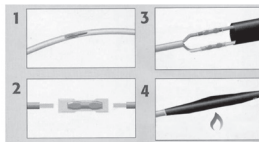

Si le câble d'origine est réutilisé

OU

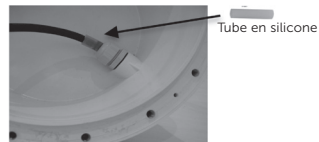

Si un nouveau câble (plus fin) est utilisé

3

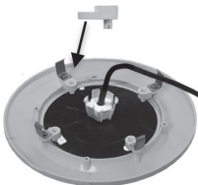

## Programmes de couleurs



### LAMPES RGB

#### 7 couleurs fixes

- 1** DEEP BLUE SEA  
Bleu saturé
- 2** DAYLIGHT BLUE  
Bleu clair
- 3** SUNSET  
Rouge orange
- 4** LOVE IS IN THE AIR  
Rouge
- 5** FOREST SPRING  
Vert
- 6** THINK PINK  
Rose
- 7** SUNSHINE  
Jaune

#### 4 couleurs dynamiques

- 8** JUNGLE BEACH  
bleu saturé  
bleu clair  
azur  
bleu  
bleu clair  
(en alternance lente)
- 9** VODOO  
rouge - bourgogne -  
violet - bordeaux  
(en alternance lente)
- 10** DISCO  
lila - rose - pêche -  
jaune clair  
vert clair  
bleu clair  
(en alternance rapide)
- 11** PARTY  
bleu - azur - vert  
- vert/rouge - rouge -  
rouge/bleu - lilas -  
rose clair - pêche -  
jaune - vert clair -  
bleu clair - lilas  
(en alternance rapide)

#### 3 nuances de blanc

- 12** WARM WHITE  
3000K
- 13** NEUTRAL WHITE  
6000K
- 14** SUN WHITE  
10.500K



### LAMPES TW

#### 7 nuances de blanc

- 1** 3200K
- 2** 3800K
- 3** 5400K
- 4** 7300K
- 5** 14800K
- 6** BLEU CLAIR
- 7** BLEU

\* Tous les programmes de couleur sont dimmables lorsque le PLP-REM ou le PLP-REM-300 sont utilisés (en mode PLC)

## Synchronisation & changement des couleurs

### Synchronisation manuelle

1. Allumez l'alimentation 12VAC et assurez-vous que toutes les lampes s'allument
2. Éteignez l'alimentation 12VAC et attendez au moins 20 sec.
3. Allumez et Éteignez
4. Allumez et Éteignez
5. Allumez
6. Toutes les lampes doivent se trouver sur le programme 1.  
Pour les lampes RGB: Bleu saturé (Deep Blue Sea)  
Pour les lampes TW: 3200K

### Changement des couleurs

Éteignez les lampes et immédiatement réallumer

La lampe passe au prochain programme de couleurs ( 1 --> 14 )

### Memorisation de la dernière couleur

Éteignez la lampe pour MINIMUM 20 secondes

La dernière couleur choisie a été mémorisée

L'utilisation des unités PLP-REM ou PLP-REM-300 permet des fonctions étendues telles que la synchronisation automatique, la gradation et le contrôle DMX / RS485.



## Résolution des problèmes

### PROBLÈME

- Le projecteur clignote

### SOLUTION

- Allumez les projecteurs  
Pour les lampes RGB : sélectionnez le programme de couleurs Sun White
- Retirer la lampe de l'eau, Dévisser les clips, Retirez le joint et la veste de câble noir, Afin que vous puissiez atteindre les contacts en laiton à l'intérieur du bloc connecteur (Ne retirez pas le bloc connecteur)
- Mesurez la tension aux bornes de la lampe
- La tension de la lampe devrait être d'au moins 10 VAC 50/60 Hz.  
Si la tension électrique mesurée est inférieure à 10 VAC:
  - Vérifiez la tension de sortie aux bornes du transformateur. Cette tension devrait être comprise entre 12 VAC et 14 VAC. Vérifiez que l'indice VA du transformateur utilisé est suffisant pour alimenter toutes les lampes raccordées
  - Si la tension de sortie du transformateur est correcte, installez un câble de section plus grand entre le transformateur et la lampe (voir p. 40-45)

- Certaines lampes installées dans la piscine suivent des programmes de couleurs différents

Assurez-vous que toutes les lampes soient raccordées à la même ligne électrique de 12 VAC. Effectuez la synchronisation comme expliqué à la page 48 (uniquement pour un interrupteur marche-arrêt classique)

## Inhalt

Technische Spezifikationen	Seite 51
Bemerkungen	Seite 52
Lieferumfang	Seite 52
Installationsanleitung	Seite 53-54-55
Anleitung zur Verkabelung 1	Seite 56
Anleitung zur Verkabelung 2	Seite 58
Verkabelung Bemerkungen	Seite 60
Nachrüsten für PAR56-Halterung (nur PLP170)	Seite 62
14 verschiedenen Farbmodi	Seite 63
Synchronisation & Farbeinstellung	Seite 64
Störungsbehebung	Seite 65

**DURAVISION**

## Technische Spezifikationen

Bestellnummer	Beschreibung	Spannung	Leistung	Nom. Tc	Lumen
PLP050-RGB	RGB-Farbe 50 mm	10-14 VAC	10 W	n.a.	400 lm
PLP100-RGB	RGB-Farbe 100 mm	10-14 VAC	45 W	n.a.	1700 lm
PLP170-RGB	RGB-Farbe 170 mm	10-14 VAC	75 W	n.a.	3000 lm
PLP050-WH	Kaltweiß 50 mm	10-14 VAC	6 W	7000K	600 lm
PLP100-WH	Kaltweiß 100 mm	10-14 VAC	30 W	7000K	2600 lm
PLP170-WH	Kaltweiß 170 mm	10-14 VAC	60 W	7000K	5500 lm
PLP050-WW	Warmweiß 50 mm	10-14 VAC	6 W	3300K	540 lm
PLP100-WW	Warmweiß 100 mm	10-14 VAC	30 W	3300K	2350 lm
PLP170-WW	Warmweiß 170 mm	10-14 VAC	60 W	3300K	4950 lm
PLP050-BL	Blau 50 mm	10-14 VAC	6 W	n.a.	165 lm
PLP100-BL	Blau 100 mm	10-14 VAC	25 W	n.a.	470 lm
PLP170-BL	Blau 170 mm	10-14 VAC	60 W	n.a.	1450 lm
PLP050-TW	Abstimmbares weiß 50 mm	10-14 VAC	10 W	3000-6500K	500 lm
PLP100-TW	Abstimmbares weiß 100 mm	10-14 VAC	45 W	3000-6500K	2150 lm
PLP170-TW	Abstimmbares weiß 170 mm	10-14 VAC	75 W	3000-6500K	4250 lm



Betrieb ausschließlich mit  
Sicherheitstransformator

Minimale Eingangsspannung: **10 VAC 50/60 Hz**  
(an Leuchtenklemme)

Nominale Eingangsspannung: **12 VAC 50/60 Hz**  
(an Leuchtenklemme)

Maximale Eingangsspannung: **14 VAC 50/60 Hz**  
(an Leuchtenklemme)

Leistungsfaktor: **> 0,90**



IEC Schutzklasse III

Der Betrieb an Gleichspannungen ist NICHT erlaubt

Maximale Wassertemperatur: **+40°C**

Lampen müssen aufbewahrt  
werden aus Eiszonen

IP-Schutzart:

**IP68**  
gemessen bei 3m Tiefe  
max Tiefe = 3m

## Bemerkungen

Die Leuchte ist wartungsfrei. Wenn die Leuchte ausgetauscht werden muss, muss sie vollständig aus dem Wasser entfernt werden



Wenn das externe flexible Kabel oder Kabel dieser Leuchte beschädigt ist, wird es ausschließlich durch den Hersteller oder seinen Kundendienst oder eine ähnliche qualifizierte Person ersetzt, um Gefahren zu vermeiden



*Adagio<sup>PRO</sup> Poolstrahler müssen während des Betriebs vollständig unter Wasser sein. Die Fixierung der Strahler in einer Halterung mit Kleber oder Silikon ist nicht erlaubt. Wenn Sie diese Anweisungen nicht befolgen, erlischt die Garantie.*

## Lieferumfang

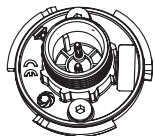

ADAGIO<sup>PRO</sup> Strahler  
(50, 100 oder 170 mm)

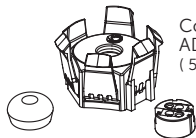

Connection Kit  
ADAGIO<sup>PRO</sup>  
( 513-0152 oder 513-0219 )

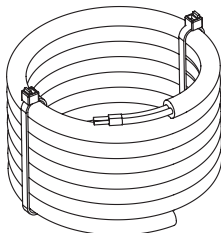

4m Kabel



Betriebsanleitung

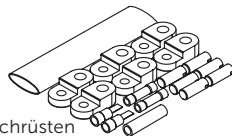

Nachrüsten  
(nur für 170 mm Modell)

## Frontring Montage

Bitte wenden Sie sich an  
Ihren lokalen Händler für  
Werkzeugsatz: 513-0151  
(nicht enthalten)

Strahler

Frontring

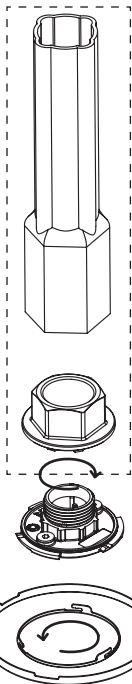

## Installationsanleitung

### Anschluss Montage

4m Kabel

Klippmutter

Silikondichtung

Anschluss

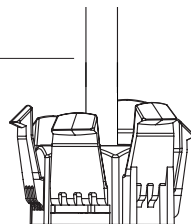

Details:  
Seite 54  
& 55

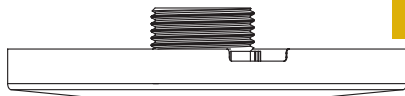

DE

## Anschluss Montage

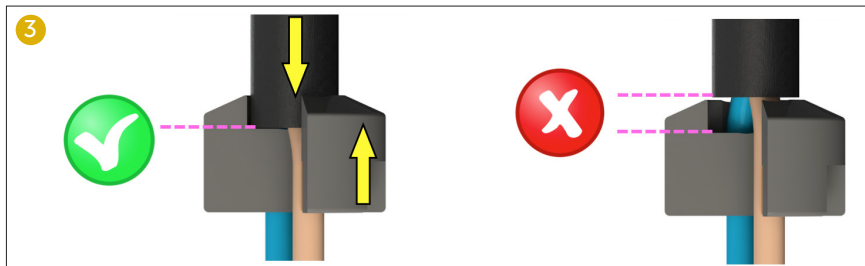
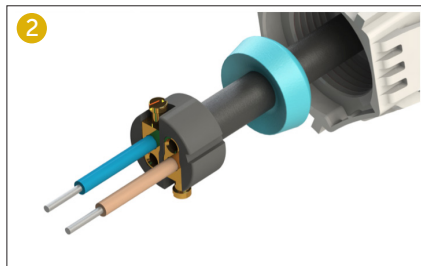
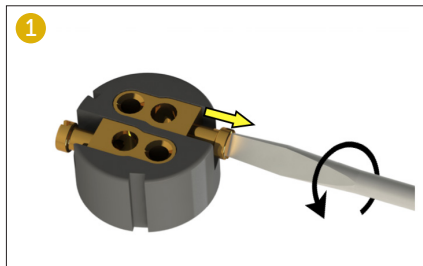

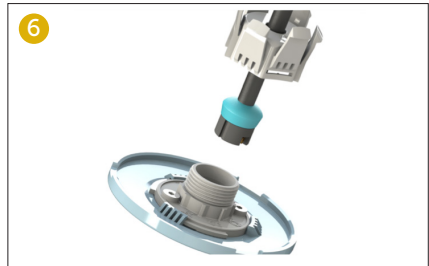
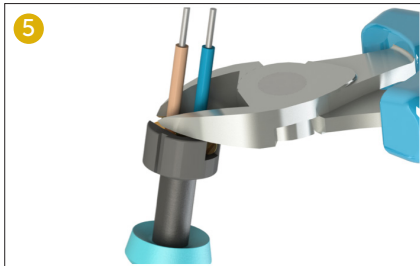
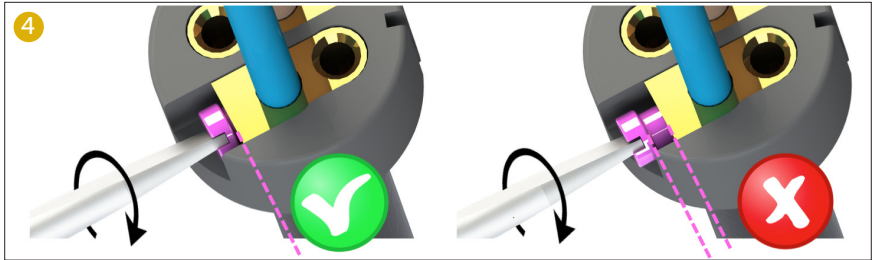

# Anleitung zur Verkabelung 1

## Für neue Installationen

Jede Lampe wird über ein separates Kabel mit dem Transformator verbunden

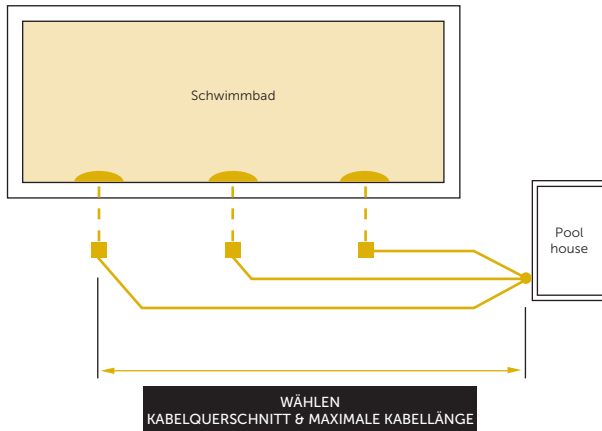

--- 4m Kabel im Lieferumfang enthalten















— Separates Kabel (nicht enthalten)



Verwenden Sie immer einen Ringkerntransformator



WÄHLEN  
KABELQUERSCHNITT & MAXIMALE KABELLÄNGE

STRAHLERTYP	1,5mm <sup>2</sup>	2,5mm <sup>2</sup>	4,0mm <sup>2</sup>	6,0mm <sup>2</sup>	10mm <sup>2</sup>	VA TRANSFORMATOR (12VAC)*	
	 PLP050-WH						
	 PLP050-WW	122m	204m	326m	490m	820m	8 VA
	 PLP050-BL						
	 PLP050-RGB / TW	79m	132m	212m	318m	530m	12 VA
	 PLP100-WH						
	 PLP100-WW	26m	43m	69m	104m	173m	32 VA
	 PLP100-BL						
	 PLP100-RGB / TW	15m	25m	41m	61m	100m	48 VA
	 PLP170-WH						
	 PLP170-WW	11m	19m	30m	46m	75m	66 VA
	 PLP170-BL						
	 PLP170-RGB / TW	8m	14m	23m	35m	57m	80 VA

**STABILER BETRIEB DER LAMPE KANN NUR ERREICHT WERDEN, WENN DER VERWENDETE KABELQUERSCHNITT MINDESTENS DEN EMPFOHLENE WERTEN IN DER OBIEN TABELLE ENTSPRICHT.**

\* Die addierte Wattzahl aller Strahler darf die Wattleistung des Transformators nicht überschreiten.  
Die angegebenen Kabellängen wurden unter Berücksichtigung eines größtmöglichen Spannungsabfalls in der elektrischen Verkabelung berechnet.

## Anleitung zur Verkabelung 2

### Für bestehende Installationen oder andere

Alle Strahler werden über 1 Kabel mit dem Transformator verbunden.

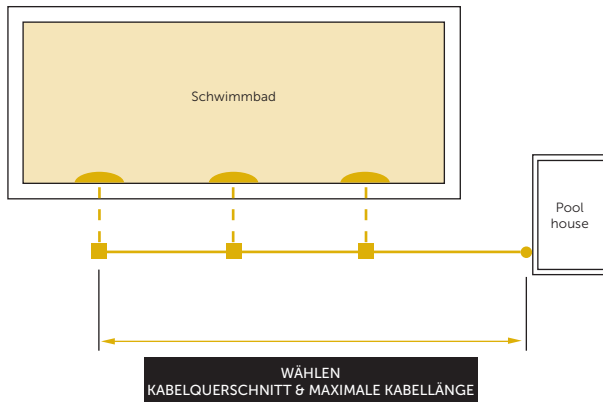



















- - - - 4m Kabel im Lieferumfang enthalten
- Separates Kabel (nicht enthalten)



Diese Einrichtung wird nicht für Installationen bevorzugt, in denen ein PLP-REM(-300) benutzt wird

Verwenden Sie immer einen Ringkerntransformator

WÄHLEN  
KABELQUERSCHNITT & MAXIMALE KABELLÄNGE

STRAHLERTYP		QTY	2,5mm <sup>2</sup>	4,0mm <sup>2</sup>	6,0mm <sup>2</sup>	10mm <sup>2</sup>	VA TRANSFORMATOR (12VAC)
	 PLP050-WH	1	204m	326m	490m	820m	8
	 PLP050-WW	2	102m	163m	245m	410m	16
	 PLP050-BL	3	68m	108m	163m	273m	24
		4	51m	81m	122m	205m	32
		1	132m	212m	318m	530m	12
	 PLP050-RGB / TW	2	66m	106m	159m	265m	24
		3	44m	70m	106m	176m	36
		4	33m	53m	79m	132m	48
	 PLP100-WH	1	43m	69m	104m	173m	32
	 PLP100-WW	2	21m	34m	52m	86m	64
	 PLP100-BL	3	14m	23m	34m	57m	96
		4	10m	17m	26m	43m	128
		1	25m	41m	61m	100m	48
	 PLP100-RGB / TW	2	12m	20m	30m	50m	96
		3	8m	13m	20m	33m	144
		4	6m	10m	15m	25m	192
	 PLP170-WH	1	19m	30m	46m	75m	66
	 PLP170-WW	2	9m	15m	23m	37m	132
	 PLP170-BL	3	6m	10m	15m	25m	198
		4	-	6m	11m	18m	264
		1	14m	23m	35m	57m	80
	 PLP170-RGB / TW	2	7m	11m	17m	28m	160
		3	-	7m	11m	19m	240
		4	-	5m	8m	14m	320

**STABILER BETRIEB DER LAMPE KANN NUR ERREICHT WERDEN, WENN DER VERWENDETE KABELQUERSCHNITT MINDESTENS DEN EMPFOHLENE WERTEN IN DER OBIGEN TABELLE ENTSPRICHT.**

## Verkabelung Bemerkungen

### Für Installationen mit PLP-REM & PLP-REM-300

Andere Geräte wie Frequenzumrichter und Elektromotoren können übermäßiges Rauschen an der Stromversorgung 230VAC / 400VAC erzeugen.

Dieses Rauschen könnte in die angrenzende 12VAC Stromleitung eingespeist werden und stören die Stromleitung Kommunikation zu den Adagio<sup>Pro</sup> RGB Lichter.

Um dies zu verhindern, beachten Sie bitte Folgendes:



**Halten Sie 230VAC / 400VAC Stromleitung Kabel mindestens 50cm getrennt über ihre volle Länge von der 12VAC Stromleitung zu jedem RGB Lichter**



**Mischen Sie keine 12VAC und 230VAC / 400VAC Netzkabel in das gleiche Kabeltrasse**

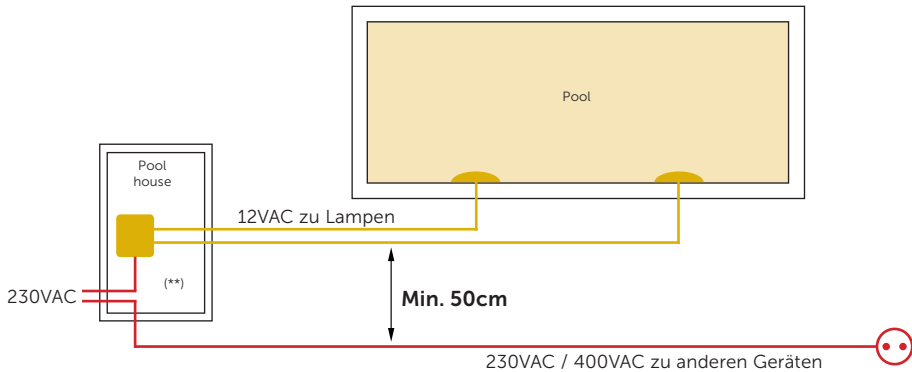

**(\*\*) Mischen Sie keine 12VAC und 230VAC / 400VAC Netzkabel in das gleiche Kabeltrasse**

## Nachrüsten für PAR56-Halterung (nur PLP170)

1



2

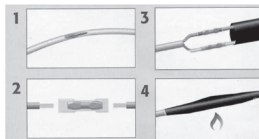

Bei Wiederverwendung eines alten Kabels

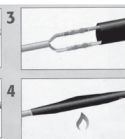

ODER

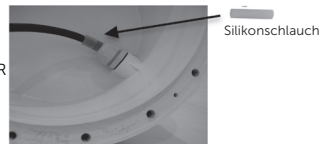

Bei Verwendung eines (dünneren) neuen Kabels

3



## Farbmodi

### RGB-STRAHLER

#### 7 feste Farben

- 1** DEEP BLUE SEA  
Tiefblau
- 2** DAYLIGHT BLUE  
Hellblau
- 3** SUNSET  
Orangerot
- 4** LOVE IS IN THE AIR  
Rot
- 5** FOREST SPRING  
Grün
- 6** THINK PINK  
Rosa
- 7** SUNSHINE  
Gelb

#### 4 dynamische Lichter

- 8** JUNGLE BEACH  
Tiefblau  
Hellblau  
Azurblau  
Mittelblau  
Hellblau  
(Langsame Farbänderung)
- 9** VODOO  
Rot - Weinrot -  
Violett - Bordeaux  
(Langsame Farbänderung)
- 10** DISCO  
Lila - Rosa - Apricot -  
Hellgelb  
Hellgrün  
Hellblau  
(schnelle Farbänderung)
- 11** PARTY  
Blau - Azurblau -  
Grün - Grün/rot -  
rot - Rot/Blau - Lila -  
Hellrosa - Apricot -  
Gelb - Hellgrün -  
Hellblau - Lila  
(schnelle Farbänderung)

#### 3 Weißtöne

- 12** WARM WHITE  
3000K
- 13** NEUTRAL WHITE  
6000K
- 14** SUN WHITE  
10.500K

### TW-STRAHLER

#### 7 Weißtöne

- 1** 3200K
- 2** 3800K
- 3** 5400K
- 4** 7300K
- 5** 14800K
- 6** HELLBLAU
- 7** BLAU

\* Alle Farbprogramme sind dimmbar, wenn PLP-REM oder PLP-REM-300 verwendet werden (im PLC-Modus)

## Synchronisation & Farbeinstellung

### Manuelle Synchronisation

1. Schalten Sie die 12V AC-Netzspannung ein und prüfen Sie, dass alle Strahler leuchten.
2. Schalten Sie die 12V AC-Netzspannung AUS und warten Sie 20 sek.
3. Schalten Sie EIN und wieder AUS
4. Schalten Sie EIN und wieder AUS
5. Schalten Sie EIN
6. Die Lampen sollten nun alle auf Farbprogramm 1 stehen:  
Für RGB-Lampen: Tiefblau (Deep Blue Sea)  
Für TW-Lampen: 3200K

### Änderung der Farbe

Schalten Sie die Lampen schnell AUS und wieder EIN

Die Lampe springt zum nächsten Farbprogramm (1 --> 14)

### Farbe Speichern

Schalten Sie die Lampe für MINIMUM 20 Sekunden AUS

Die zuletzt gewählte Farbe wurde nun gespeichert

Die Verwendung von PLP-REM- oder PLP-REM-300-Steuereinheiten ermöglicht erweiterte Funktionen wie automatische Synchronisierung, Dimmen und DMX / RS485-Steuerung.



## Störungsbehebung

### STÖRUNG

- Die Poolbeleuchtung flackert

### SOLUTION

- Schalten Sie die Strahler ein.  
Bei RGB-Strahlern: Wählen Sie den Sun White-Modus aus.
- Die Lampe aus dem Wasser nehmen, Schrauben Sie die Klammernmutter ab, Ziehen Sie die Dichtung und den schwarzen Kabelmantel zurück, So können Sie die Messingkontakte innerhalb des Steckverbinderblocks erreichen (Entfernen Sie nicht den Steckerblock)
- Messen Sie die Spannung an den Leuchtenklemmen.
- Die Spannung an den Klemmen sollte mindestens 10V AC 50/60 Hz betragen. Bei einer Netzspannung unter 10V AC:
  - Kontrollieren Sie die Ausgangsspannung an den Transformatoranschlüssen. Die Spannung sollte zwischen 12VAC und 14VAC betragen. Überprüfen Sie, ob die genutzte Wattleistung des Transformators für den Betrieb aller angeschlossenen Strahler ausreicht.
  - Sollte die Transformatorleistung ausreichend sein, schließen Sie ein dickeres Kabel zwischen Transformator und Strahler an. (Anleitung zur Verkabelung S. 56-61)

- Die Poolstrahler sind zum Teil in einem anderen Farbmodus eingestellt.

Stellen Sie sicher, dass alle Strahler an dasselbe 12VAC-Stromnetz angeschlossen sind. Führen Sie die Synchronisation gemäß der auf S. 64 beschriebenen Anleitung durch (nur bei klassischem Ein-/Ausschalter).

## Índice

Especificaciones técnicas	<b>Página 67</b>
Notas	<b>Página 68</b>
Contenido de la caja	<b>Página 68</b>
Instrucciones de instalación	<b>Página 69-70-71</b>
Instrucciones del cableado configuración 1	<b>Página 72</b>
Instrucciones del cableado configuración 2	<b>Página 74</b>
Cableado notas	<b>Página 76</b>
Retrofit en el PAR56 (solamente PLP170)	<b>Página 78</b>
14 programas de color	<b>Página 79</b>
Sincronizado y cambio de color	<b>Página 80</b>
Reparación de averías	<b>Página 81</b>

**DURAVISION**

## Especificaciones técnicas

Referencia	Descripción	Voltaje	Poder	Nom. Tc	Lumen
PLP050-RGB	Color del RGB 50 mm	10-14 VAC	10 W	n.a.	400 lm
PLP100-RGB	Color del RGB 100 mm	10-14 VAC	45 W	n.a.	1700 lm
PLP170-RGB	Color del RGB 170 mm	10-14 VAC	75 W	n.a.	3000 lm
PLP050-WH	Blanco Sun 50 mm	10-14 VAC	6 W	7000K	600 lm
PLP100-WH	Blanco Sun 100 mm	10-14 VAC	30 W	7000K	2600 lm
PLP170-WH	Blanco Sun 170 mm	10-14 VAC	60 W	7000K	5500 lm
PLP050-WW	Blanco cálido 50 mm	10-14 VAC	6 W	3300K	540 lm
PLP100-WW	Blanco cálido 100 mm	10-14 VAC	30 W	3300K	2350 lm
PLP170-WW	Blanco cálido 170 mm	10-14 VAC	60 W	3300K	4950 lm
PLP050-BL	50 mm fijo azul	10-14 VAC	6 W	n.a.	165 lm
PLP100-BL	100 mm fijo azul	10-14 VAC	25 W	n.a.	470 lm
PLP170-BL	170 mm fijo azul	10-14 VAC	60 W	n.a.	1450 lm
PLP050-TW	Sintonizable blanco 50 mm	10-14 VAC	10 W	3000-6500K	500 lm
PLP100-TW	Sintonizable blanco 100 mm	10-14 VAC	45 W	3000-6500K	2150 lm
PLP170-TW	Sintonizable blanco 170 mm	10-14 VAC	75 W	3000-6500K	4250 lm



Para operación solamente con un transformador del aislamiento de la seguridad

Voltaje de entrada mínimo: **10 VAC 50/60 Hz**  
(en los terminales de la lámpara)

Voltaje de entrada nominal: **12 VAC 50/60 Hz**  
(en los terminales de la lámpara)

Voltaje de entrada máximo: **14 VAC 50/60 Hz**  
(en los terminales de la lámpara)



Clase de protección IEC III

No se permite el funcionamiento con tensiones DC

Temperatura máxima del agua: **+40°C**

Las lámparas tienen que ser guardadas fuera de zonas del hielo

Tasa de protección de ingreso: **IP68**

Medido en 3m  
máxima profundidad = 3m

## Mantenimiento

La luminaria no requiere mantenimiento

Si la luminaria necesita ser reemplazada, necesita ser completamente removida del agua



Si el cable o el cable flexible externo de esta luminaria está dañado, éste será sustituido exclusivamente por el fabricante o su agente de servicio o una persona cualificada similar para evitar peligros



*Las lámparas Moonlight Pool deben estar completamente sumergidas en agua durante el funcionamiento. No se permite reparar lámparas con adhesivos o kits de silicona en un conducto. Si no lo hace, se anulará la garantía.*

## Contenido de la caja

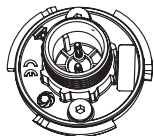

Lámpara ADAGIO<sup>PRO</sup>  
(50,100 o 170 mm)

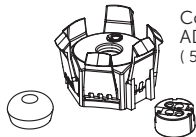

Connection Kit  
ADAGIO<sup>PRO</sup>  
( 513-0152 o 513-0219 )

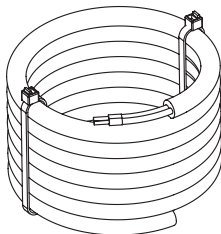

Cable de 4m



Manual

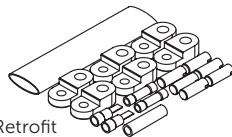

Equipo Retrofit  
(solamente para modelos de 170 mm)

## Instrucciones de instalación

### Placa frontal de montaje

Contacte con su distribuidor local para el juego de herramientas: 513-0151 (no incluido)

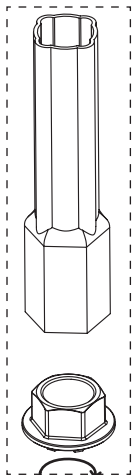

Lámpara

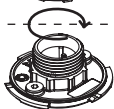

Placa frontal

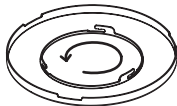

### Montaje del conector

Cable de 4 m

Tuerca de clips

Junta de silicona

Conector

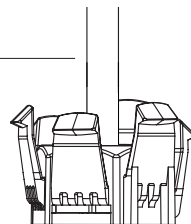

Detalles:  
Página  
70 y 71

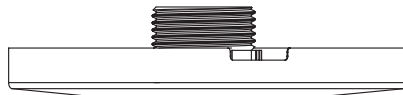

## Instalación del conector

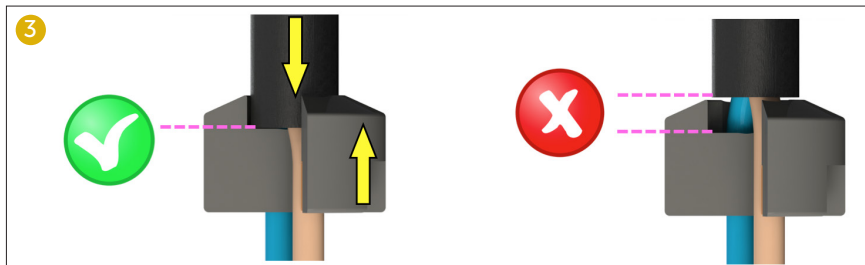
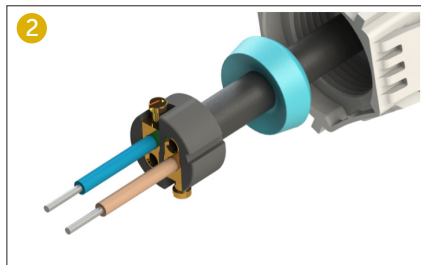
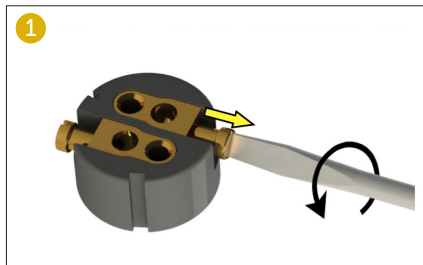

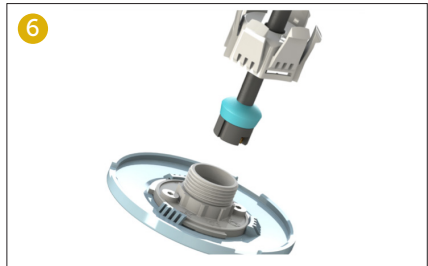
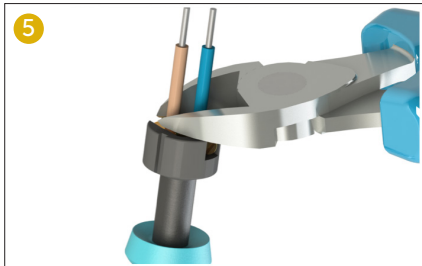

## Instrucciones del cableado configuración 1

### Para nuevas instalaciones

Cada lámpara está conectada con el transformador por un cable separado

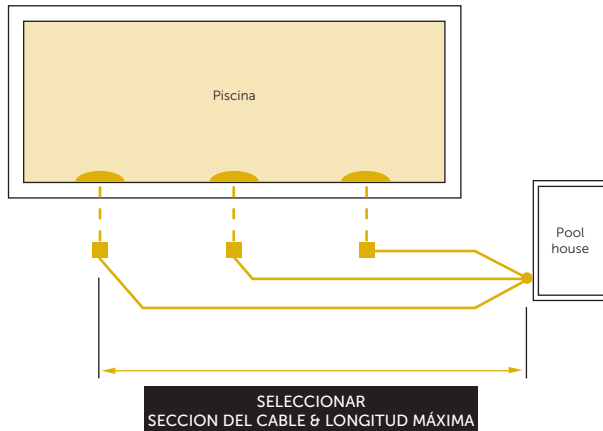















- Cable de 4m incluido en paquete de la lámpara
- Cable separado (no incluido)



Siempre se debe utilizar un transformador con núcleo toroidal



**SELECCIONAR  
SECCION DEL CABLE & LONGITUD MÁXIMA**

TIPO DE LÁMPARA	1,5mm <sup>2</sup>	2,5mm <sup>2</sup>	4,0mm <sup>2</sup>	6,0mm <sup>2</sup>	10mm <sup>2</sup>	VA TRANSFORMADOR (12VAC)*	
	 PLP050-WH	122m	204m	326m	490m	820m	8 VA
	 PLP050-WW						
	 PLP050-BL						
	 PLP050-RGB / TW						
	 PLP100-WH	26m	43m	69m	104m	173m	32 VA
	 PLP100-WW						
	 PLP100-BL						
	 PLP100-RGB / TW						
	 PLP170-WH	11m	19m	30m	46m	75m	66 VA
	 PLP170-WW						
	 PLP170-BL						
	 PLP170-RGB / TW						

**FUNCIONAMIENTO CORRECTO DE LA LÁMPARA SE GARANTIZA SOLAMENTE CUANDO LA SECCION DEL CABLE  
INSTALADO EXCEDE LOS VALORES ACONSEJADOS EN LA TABLA ANTERIOR**

\* El indice VA des transformador debe ser mayor o igual a la suma del indices VA de todas las lámparas conectadas  
Cada perdida de tension por cable esta calculada en el peor de los casos

## Instrucciones del cableado configuración 2

### Para instalaciones existentes o de otro tipo

Todas las lámparas están conectadas con el transformador vía 1 cable

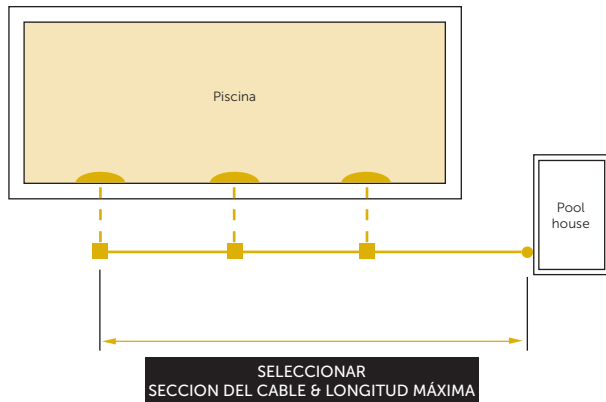













- Cable de 4m incluido en paquete de la lámpara
- Separate cable ( not included )



Esta configuración no es preferida para las instalaciones donde se usa un PLP-REM(-300)  
Siempre se debe utilizar un transformador con núcleo toroidal

**SELECCIONAR  
SECCION DEL CABLE & LONGITUD MÁXIMA**

		TIPO DE LÁMPARA	QTY	2,5mm <sup>2</sup>	4,0mm <sup>2</sup>	6,0mm <sup>2</sup>	10mm <sup>2</sup>	VA TRANSFORMADOR (12VAC)
		PLP050-WH	1	204m	326m	490m	820m	8
		PLP050-WW	2	102m	163m	245m	410m	16
		PLP050-BL	3	68m	108m	163m	273m	24
		PLP050-BL	4	51m	81m	122m	205m	32
			1	132m	212m	318m	530m	12
		PLP050-RGB / TW	2	66m	106m	159m	265m	24
			3	44m	70m	106m	176m	36
			4	33m	53m	79m	132m	48
		PLP100-WH	1	43m	69m	104m	173m	32
		PLP100-WW	2	21m	34m	52m	86m	64
		PLP100-BL	3	14m	23m	34m	57m	96
		PLP100-BL	4	10m	17m	26m	43m	128
			1	25m	41m	61m	100m	48
		PLP100-RGB / TW	2	12m	20m	30m	50m	96
			3	8m	13m	20m	33m	144
			4	6m	10m	15m	25m	192
		PLP170-WH	1	19m	30m	46m	75m	66
		PLP170-WW	2	9m	15m	23m	37m	132
		PLP170-BL	3	6m	10m	15m	25m	198
		PLP170-BL	4	-	6m	11m	18m	264
			1	14m	23m	35m	57m	80
		PLP170-RGB / TW	2	7m	11m	17m	28m	160
			3	-	7m	11m	19m	240
			4	-	5m	8m	14m	320

**FUNCIONAMIENTO CORRECTO DE LA LÁMPARA SE GARANTIZA SOLAMENTE CUANDO LA SECCION DEL CABLE  
INSTALADO EXCEDE LOS VALORES ACONSEJADOS EN LA TABLA ANTERIOR**

## Cableado notas

### Para instalaciones con PLP-REM & PLP-REM-300

Otros equipos como los convertidores de frecuencia y los motores eléctricos pueden generar parasitos excesivos en el circuito de alimentación de 230VAC / 400VAC.

Estos parasitos pueden penetrar el circuito de alimentación de 12VAC situado en la proximidad, y perturbar el circuito de alimentación hacia las lámparas Adagio<sup>Pro</sup> RGB.

Para evitar esto, por favor, tenga cuidado de lo siguiente:



**Mantenga los cables del circuito de alimentación de 230VAC / 400VAC por lo menos 50cm separados sobre toda su longitud desde el circuito de alimentación de 12VAC hacia cualquier lámpara RGB**



**No mezcle cables del circuito de alimentación de 12VAC y 230VAC / 400VAC en el mismo conducto de cables**

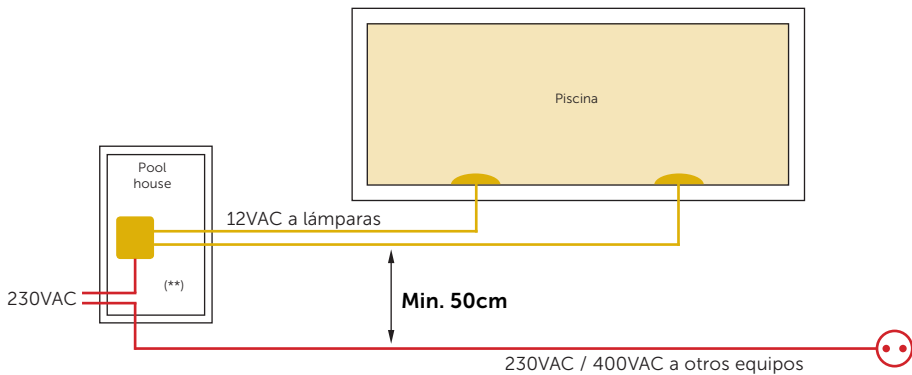

**(\*\*) No mezcle cables del circuito de alimentación de 12VAC y 230VAC / 400VAC en el mismo conducto de cables**

## Retrofit en nicho PAR56 (solamente PLP170)

1



2

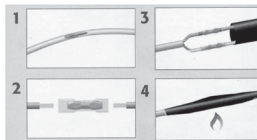

Solo si se usa cable viejo

OR

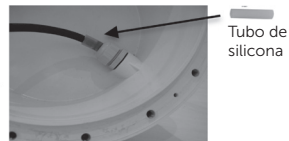

Solo si se usa cable nuevo (más delgado)

3



## Programas del color



### LÁMPARAS RGB

#### 7 colores fijos

- 1 DEEP BLUE SEA**  
Azul saturado
- 2 DAYLIGHT BLUE**  
Azul claro
- 3 SUNSET**  
Rojo anaranjado
- 4 LOVE IS IN THE AIR**  
Rojo
- 5 FOREST SPRING**  
Verde
- 6 THINK PINK**  
Rosa
- 7 SUNSHINE**  
Amarillo

#### 4 colores dinámicos

- 8 JUNGLE BEACH**  
Azul saturado  
Azul claro  
Azul celeste  
Azul medio  
Azul claro  
(cambio lento)
- 9 VOODOO**  
Rojo - Rojo vino -  
Púrpura - Burdeos  
(cambio lento)
- 10 DISCO**  
Lila - rosa -  
melocotón - amarillo  
claro - verde claro -  
azul claro  
(cambio rápido)
- 11 PARTY**  
Azul - azul celeste -  
verde - verde/rojo -  
rojo - rojo/azul - lila -  
rosa claro - melocotón -  
amarillo - verde claro -  
azul claro - lila  
(cambio rápido)

#### 3 tonos blancos

- 12 WARM WHITE**  
3000K
- 13 NEUTRAL WHITE**  
6000K
- 14 SUN WHITE**  
10.500K



### LÁMPARAS TW

#### 7 tonos blancos

- 1 3200K**
- 2 3800K**
- 3 5400K**
- 4 7300K**
- 5 14800K**
- 6 AZUL CLARO**
- 7 AZUL**

\* Todos los programas de color son atenuables cuando se utilizan PLP-REM o PLP-REM-300 (en modo PLC)

## Sincronización y cambio de color

### Sincronización manual

1. Encienda el circuito de 12 VAC y asegúrese de que todas las lámparas se enciendan
2. Apague el circuito de 12 VAC y espere por lo menos 20 segundos
3. Encienda y apague
4. Encienda y apague
5. Encienda
6. Las lámparas deben estar todas en programa 1  
Para lámparas RGB: Azul saturado (Deep Blue Sea)  
Para lámparas TW: 3200K

### Cambio de color

Apague rápidamente las lámparas y vuelva a encenderlas  
La lámpara salta al siguiente programa de color (1 --> 14)

### Memorizar el color

Apague la lámpara durante un mínimo de 20 segundos  
El último color elegido ha sido memorizado

El uso de las unidades de control PLP-REM o PLP-REM-300 permite funciones extendidas tales como sincronización automática, atenuación y control DMX / RS485.



## Reparación de averías

PROBLEMA	SOLUCIÓN
<ul style="list-style-type: none"><li>La luz de la piscina está oscilando</li></ul>	<ol style="list-style-type: none"><li>Encienda las lámparas Para lámparas RGB: seleccione el programa de color Sun White</li><li>Retire la lámpara del agua, Desenroscar la tuerca de los clips, Tire hacia atrás la junta y la cubierta de cable negro, Así que usted puede alcanzar los contactos de cobre amarillo dentro del bloque de conector (No retire el bloque de conectores)</li><li>Mida el voltaje en los terminales de la lámpara (mientras la lámpara Sigue encendida)</li><li>El voltaje en la lámpara debe ser por lo menos 10 V CA 50/60hz. Si la línea voltaje medida es menor de 10 V CA:<ol style="list-style-type: none"><li>Compruebe el voltaje de salida en los terminales del transformador. Este voltaje debe estar entre 12 V CA y 14 V CA. Verifique que el índice VA del transformador usado sea suficiente para accionar todas las lámparas conectadas</li><li>Si el voltaje de salida del transformador es aceptable, entonces instale un cable más grueso entre el transformador y la lámpara. (instrucciones de cableado P. 72-77)</li></ol></li></ol>
<ul style="list-style-type: none"><li>Varios reúnen luces de la piscina muestran diferentes programas de color</li></ul>	<p>Asegúrese de que todas las lámparas están conectadas con la misma línea de 12 V CA. Ejecute la sincronización según lo explicado en la página 80 (solamente para el control clásico CONECTADO/DESCONECTADO)</p>

# EC Declarations of Conformity

We, the undersigned,

Manufacturer:  
Address, City:  
Country:

Propulsion Systems bvba  
Dooren 72, Mierchtem BE-1785  
Belgium

Declaration the following apparatus:

Product name:	LED underwater Light
Model name:	ADAGIO Pro
Used as:	PLP050-RGB, PLP050-WH, PLP050-WW, PLP100-RGB, PLP100-WH, PLP100-WW PLP170-RGB, PLP170-WH(-LC), PLP170-WW(-LC), PLP050-BL, PLP100-BL, PLP170-BL

Product description:

White and color LED lightings for swimming pools and similar applications.

**Conform with the essential requirements of the follow standards & directives:**

## CE directives

EU 1194/2012	ECO Design
EC 1907/2006	REACH
2011/65/EU	RoHS
2004/108/EC	Electromagnetic Compatibility (EMC)
2012/19/EU	WEEE waste electronic equipment

## Conformity with the following harmonised norms:

EN60598-1	General requirements and tests
EN60598-2-18	Luminaire Part 2: Luminaires for swimming pools & similar applications
EN55015	Emission
EN61457	Immunity
EN61000-3-2/3	Harmonics
EN50419	WEEE marking
EN 50581:2012	RoHS2

I hereby declare that the equipment above named has been designed to comply with the relevant sections of above referenced specifications. The unit complies with all applicable Essential Requirements of the Directives.

# CE

Name: Marc Lamberts  
Position: GM  
Place: Brussegem, Belgium  
Date: 09/12/2015

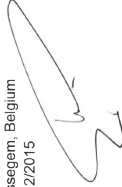



Contact details  
Contactgegevens  
Coordonnées de contact  
Kontaktdaten  
Los datos de contacto

**Propulsion Systems bvba**

Dooren 72  
1785 Merchtem, Belgium

Tel +32 2 461 02 53

Fax +32 2 706 59 60

[www.propulsionsystems.be](http://www.propulsionsystems.be)  
[info@propulsionsystems.be](mailto:info@propulsionsystems.be)



**DURAVISION**



We reserve the rights to change all or part of the contents of this document without prior notice  
We behouden het recht om de inhoud van dit document te wijzigen zonder voorafgaande kennisgeving  
Nous nous réservons le droit de modifier le contenu (entier ou partiel) du présent document sans notification préalable.  
Wir behalten uns das Recht vor den gesamten Inhalt dieses Dokuments bzw. Teile davon ohne vorherige Ankündigung zu ändern.  
Nos reservamos el derecho de cambiar total o parcial de los contenidos de este documento sin previo aviso